

IRF7105QPbF

HEXFET® Power MOSFET

- Advanced Process Technology
- Ultra Low On-Resistance
- Dual N and P Channel MOSFET
- Surface Mount
- Available in Tape & Reel
- 150°C Operating Temperature
- Lead-Free

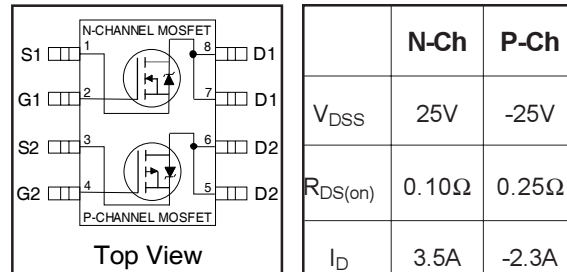

Description

These HEXFET® Power MOSFET's in a Dual SO-8 package utilize the latest processing techniques to achieve extremely low on-resistance per silicon area. Additional features of these HEXFET Power MOSFET's are a 150°C junction operating temperature, fast switching speed and improved repetitive avalanche rating. These benefits combine to make this design an extremely efficient and reliable device for use in a wide variety of applications.

The efficient SO-8 package provides enhanced thermal characteristics and dual MOSFET die capability making it ideal in a variety of power applications. This dual, surface mount SO-8 can dramatically reduce board space and is also available in Tape & Reel.

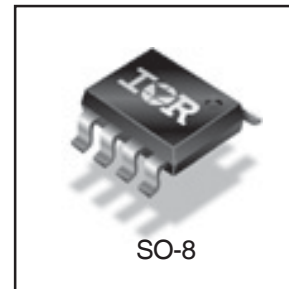

Absolute Maximum Ratings

	Parameter	Max.		Units
		N-Channel	P-Channel	
$I_D @ T_A = 25^\circ\text{C}$	Continuous Drain Current, $V_{GS} @ 10\text{V}$	3.5	-2.3	A
$I_D @ T_A = 70^\circ\text{C}$	Continuous Drain Current, $V_{GS} @ 10\text{V}$	2.8	-1.8	
I_{DM}	Pulsed Drain Current ①	14	-10	
$P_D @ T_C = 25^\circ\text{C}$	Power Dissipation	2.0		W
	Linear Derating Factor	0.016		W/°C
V_{GS}	Gate-to-Source Voltage	± 20		V
dv/dt	Peak Diode Recovery dv/dt ②	3.0	-3.0	V/nS
T_J, T_{STG}	Junction and Storage Temperature Range	-55 to + 150		°C

Thermal Resistance Ratings

	Parameter	Min.	Typ.	Max.	Units
$R_{\theta JA}$	Maximum Junction-to-Ambient ④	—	—	62.5	°C/W

IRF7105QPbF

International
IR Rectifier

Electrical Characteristics @ T_J = 25°C (unless otherwise specified)

Parameter	Description		Min.	Typ.	Max.	Units	Conditions
V _{(BR)DSS}	Drain-to-Source Breakdown Voltage	N-Ch	25	—	—	V	V _{GS} = 0V, I _D = 250μA
		P-Ch	-25	—	—		V _{GS} = 0V, I _D = -250μA
ΔV _{(BR)DSS} /ΔT _J	Breakdown Voltage Temp. Coefficient	N-Ch	—	0.030	—	V/°C	Reference to 25°C, I _D = 1mA
		P-Ch	—	-0.015	—		Reference to 25°C, I _D = -1mA
R _{DS(ON)}	Static Drain-to-Source On-Resistance	N-Ch	—	0.083	0.10	Ω	V _{GS} = 10V, I _D = 1.0A ③
		N-Ch	—	0.14	0.16		V _{GS} = 4.5V, I _D = 0.50A ③
		P-Ch	—	0.16	0.25		V _{GS} = -10V, I _D = -1.0A ③
		P-Ch	—	0.30	0.40		V _{GS} = -4.5V, I _D = -0.50A ③
V _{GS(th)}	Gate Threshold Voltage	N-Ch	1.0	—	3.0	V	V _{DS} = V _{GS} , I _D = 250μA
		P-Ch	-1.0	—	-3.0		V _{DS} = V _{GS} , I _D = -250μA
g _{fs}	Forward Transconductance	N-Ch	—	4.3	—	S	V _{DS} = 15V, I _D = 3.5A ③
		P-Ch	—	3.1	—		V _{DS} = -15V, I _D = -3.5A ③
I _{DSS}	Drain-to-Source Leakage Current	N-Ch	—	—	2.0	μA	V _{DS} = 20V, V _{GS} = 0V
		P-Ch	—	—	-2.0		V _{DS} = -20V, V _{GS} = 0V
		N-Ch	—	—	25		V _{DS} = 20V, V _{GS} = 0V, T _J = 55°C
		P-Ch	—	—	-25		V _{DS} = -20V, V _{GS} = 0V, T _J = 55°C
I _{GSS}	Gate-to-Source Forward Leakage	N-P	—	—	±100		V _{GS} = ±20V
Q _g	Total Gate Charge	N-Ch	—	9.4	27	nC	N-Channel I _D = 2.3A, V _{DS} = 12.5V, V _{GS} = 10V ③
P-Ch	—	—	10	25			
Q _{gs}	Gate-to-Source Charge	N-Ch	—	1.7	—	nC	P-Channel I _D = -2.3A, V _{DS} = -12.5V, V _{GS} = -10V
P-Ch	—	—	1.9	—			
Q _{gd}	Gate-to-Drain ("Miller") Charge	N-Ch	—	3.1	—	nC	
P-Ch	—	—	2.8	—			
t _{d(on)}	Turn-On Delay Time	N-Ch	—	7.0	20	ns	N-Channel V _{DD} = 25V, I _D = 1.0A, R _G = 6.0Ω, R _D = 25Ω ③
t _r	Rise Time	N-Ch	—	9.0	20		
		P-Ch	—	13	40		
t _{d(off)}	Turn-Off Delay Time	N-Ch	—	45	90		
		P-Ch	—	45	90		
t _f	Fall Time	N-Ch	—	25	50	ns	P-Channel V _{DD} = -25V, I _D = -1.0A, R _G = 6.0Ω, R _D = 25Ω
		P-Ch	—	37	50		
L _D	Internal Drain Inductance	N-P	—	4.0	—	nH	Between lead, 6mm (0.25in.) from package and center of die contact
L _S	Internal Source Inductance	N-P	—	6.0	—		
C _{iss}	Input Capacitance	N-Ch	—	330	—	pF	N-Channel V _{GS} = 0V, V _{DS} = 15V, f = 1.0MHz
		P-Ch	—	290	—		
C _{oss}	Output Capacitance	N-Ch	—	250	—		
		P-Ch	—	210	—		
C _{rss}	Reverse Transfer Capacitance	N-Ch	—	61	—	pF	P-Channel V _{GS} = 0V, V _{DS} = -15V, f = 1.0MHz
		P-Ch	—	67	—		

Source-Drain Ratings and Characteristics

Parameter	Description		Min.	Typ.	Max.	Units	Conditions
I _S	Continuous Source Current (Body Diode)	N-Ch	—	—	2.0	A	
		P-Ch	—	—	-2.0		
I _{SM}	Pulsed Source Current (Body Diode) ①	N-Ch	—	—	14	A	
		P-Ch	—	—	-9.2		
V _{SD}	Diode Forward Voltage	N-Ch	—	—	1.2	V	T _J = 25°C, I _S = 1.3A, V _{GS} = 0V ③
		P-Ch	—	—	-1.2		T _J = 25°C, I _S = -1.3A, V _{GS} = 0V ③
t _{rr}	Reverse Recovery Time	N-Ch	—	36	54	ns	N-Channel T _J = 25°C, I _F = 1.3A, di/dt = 100A/μs
		P-Ch	—	69	100		
Q _{rr}	Reverse Recovery Charge	N-Ch	—	41	75	nC	P-Channel T _J = 25°C, I _F = -1.3A, di/dt = 100A/μs ③
		P-Ch	—	90	180		
t _{on}	Forward Turn-On Time	N-P	Intrinsic turn-on time is negligible (turn-on is dominated by L _S +L _D)				

Notes:

- ① Repetitive rating; pulse width limited by max. junction temperature.
- ② N-Channel I_{SD} ≤ 3.5A, di/dt ≤ 90A/μs, V_{DD} ≤ V_{(BR)DSS}, T_J ≤ 150°C
P-Channel I_{SD} ≤ -2.3A, di/dt ≤ 90A/μs, V_{DD} ≤ V_{(BR)DSS}, T_J ≤ 150°C
- ③ Pulse width ≤ 300μs; duty cycle ≤ 2%.
- ④ Surface mounted on FR-4 board, t ≤ 10sec.

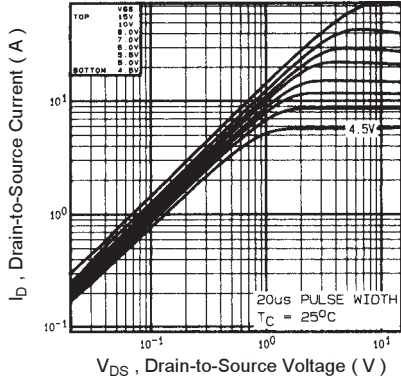

Fig 1. Typical Output Characteristics

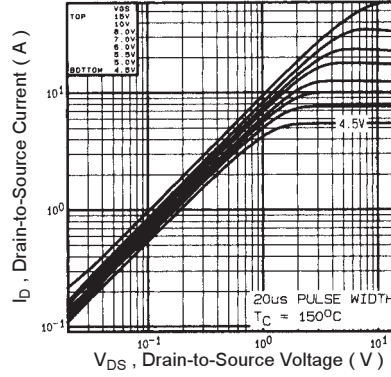

Fig 2. Typical Output Characteristics

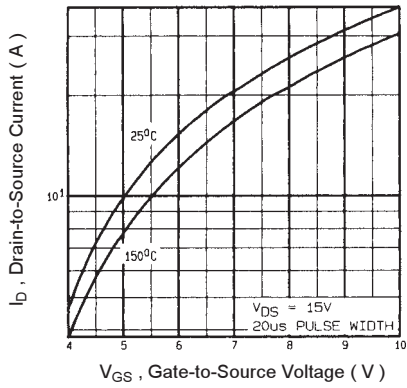

Fig 3. Typical Transfer Characteristics

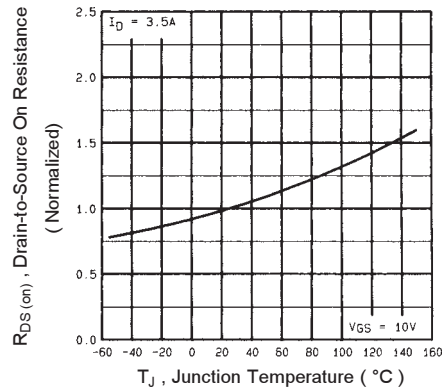

Fig 4. Normalized On-Resistance Vs. Temperature

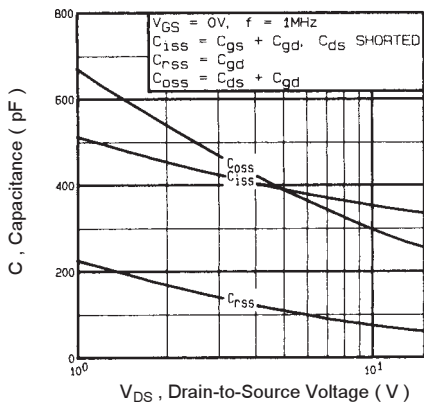

Fig 5. Typical Capacitance Vs. Drain-to-Source Voltage

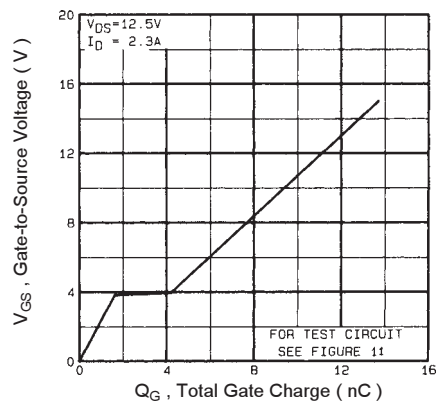

Fig 6. Typical Gate Charge Vs. Gate-to-Source Voltage

IRF7105QPbF

N-Channel

International
IR Rectifier

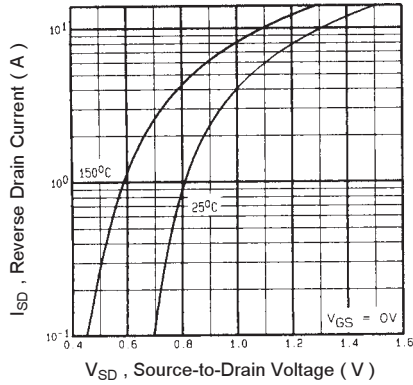

Fig 7. Typical Source-Drain Diode Forward Voltage

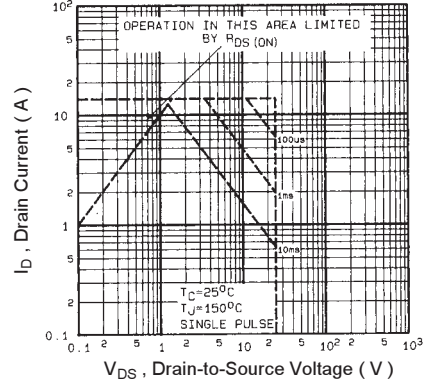

Fig 8. Maximum Safe Operating Area

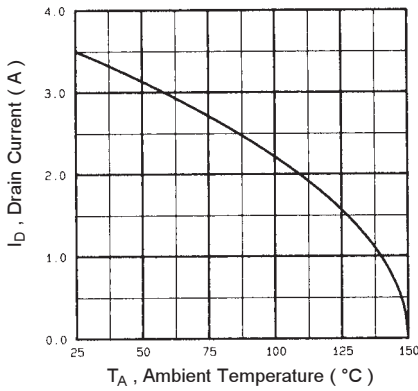

Fig 9. Maximum Drain Current Vs. Ambient Temperature

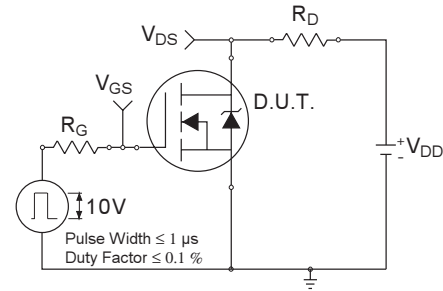

Fig 10a. Switching Time Test Circuit

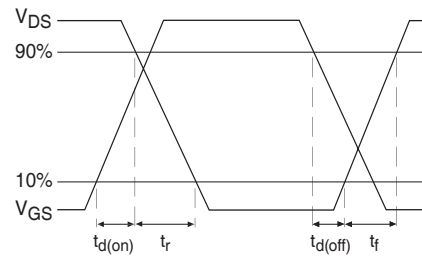

Fig 10b. Switching Time Waveforms

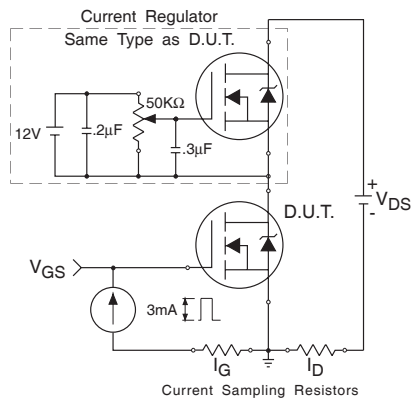

Fig 11a. Gate Charge Test Circuit

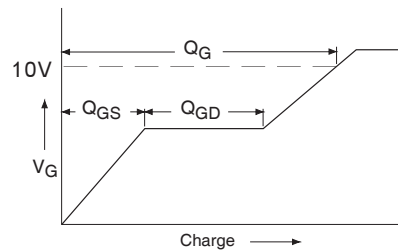

Fig 11b. Basic Gate Charge Waveform

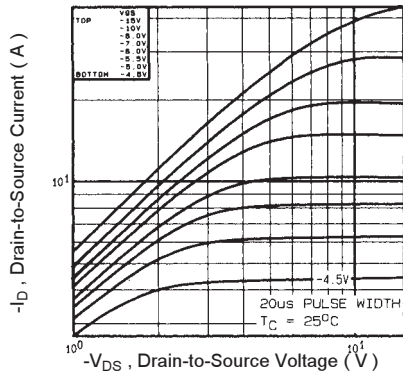

Fig 12. Typical Output Characteristics

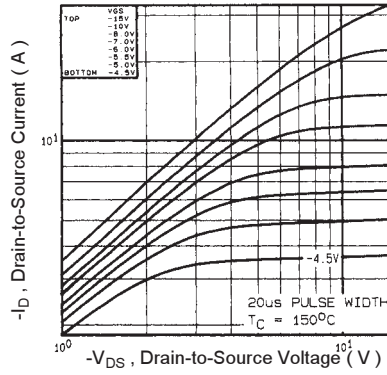

Fig 13. Typical Output Characteristics

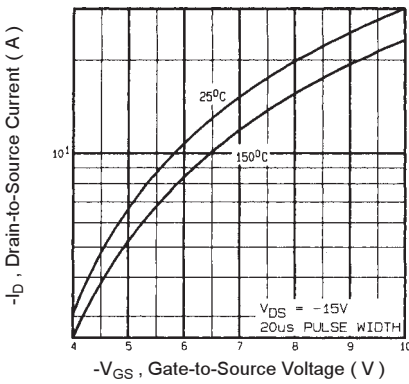

Fig 14. Typical Transfer Characteristics

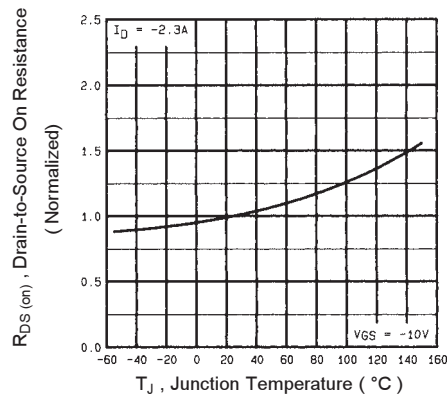

Fig 15. Normalized On-Resistance Vs. Temperature

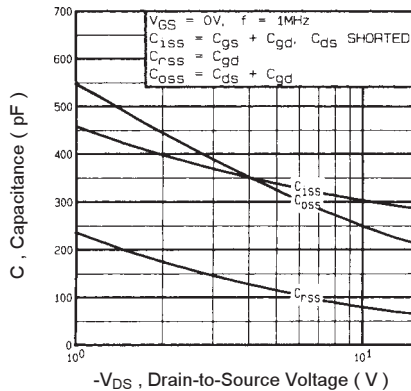

Fig 16. Typical Capacitance Vs. Drain-to-Source Voltage

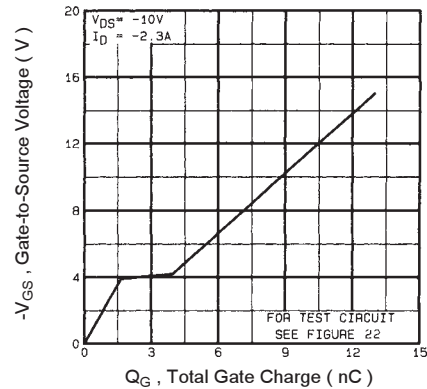

Fig 17. Typical Gate Charge Vs. Gate-to-Source Voltage

IRF7105QPbF

P-Channel

International
IR Rectifier

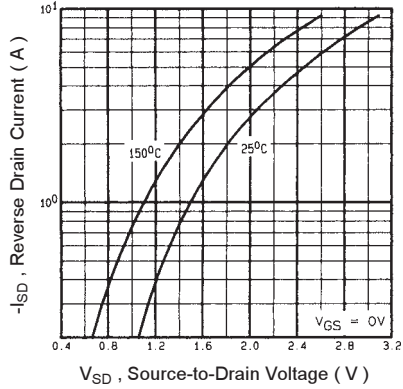

Fig 18. Typical Source-Drain Diode Forward Voltage

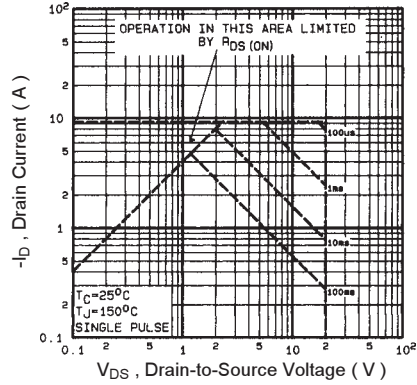

Fig 19. Maximum Safe Operating Area

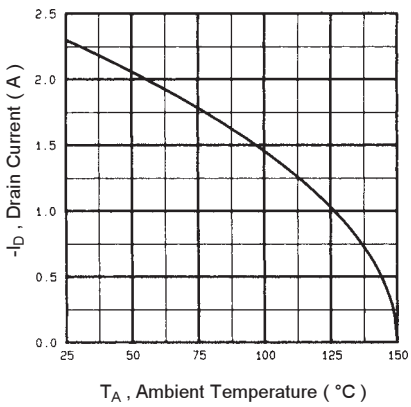

Fig 20. Maximum Drain Current Vs. Ambient Temperature

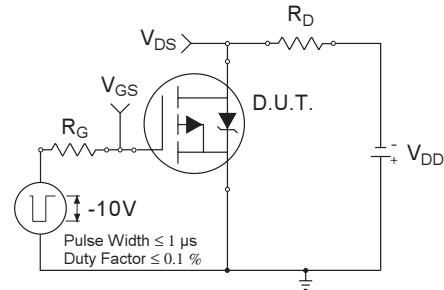

Fig 21a. Switching Time Test Circuit

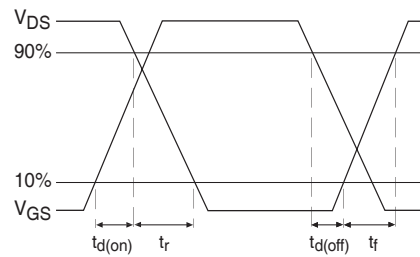

Fig 21b. Switching Time Waveforms

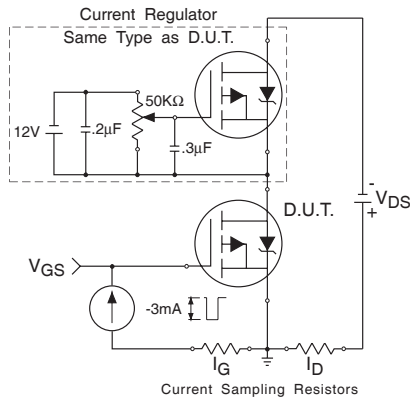

Fig 22a. Gate Charge Test Circuit

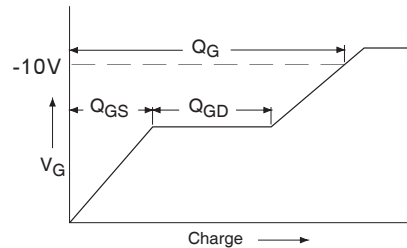

Fig 22b. Basic Gate Charge Waveform

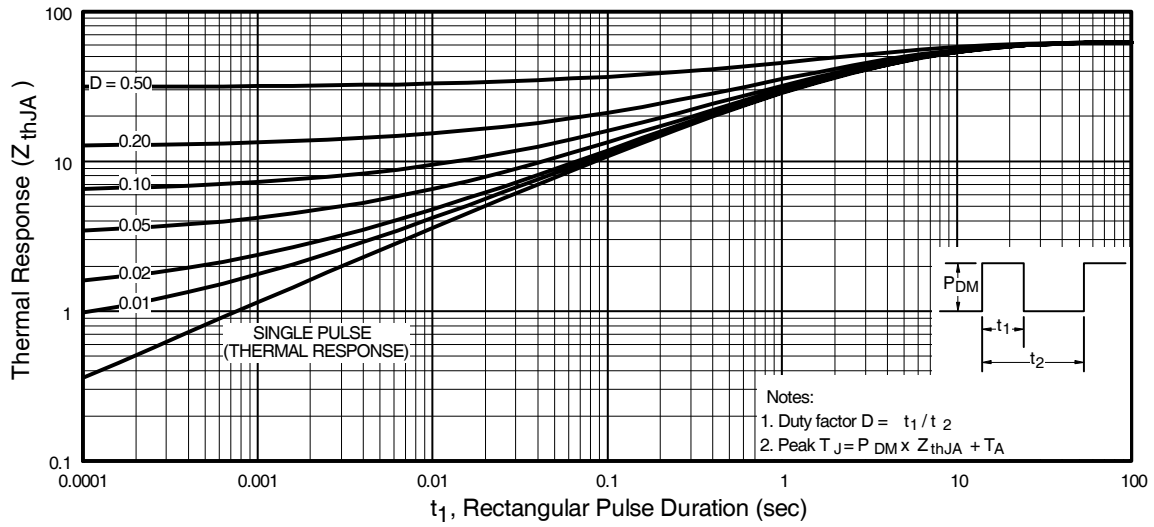
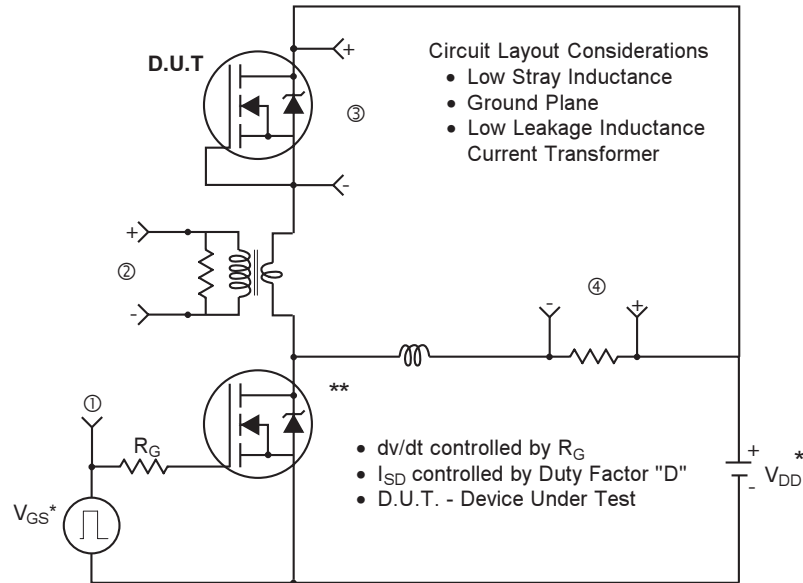

Fig 23. Maximum Effective Transient Thermal Impedance, Junction-to-Ambient

Peak Diode Recovery dv/dt Test Circuit



* Reverse Polarity for P-Channel

** Use P-Channel Driver for P-Channel Measurements

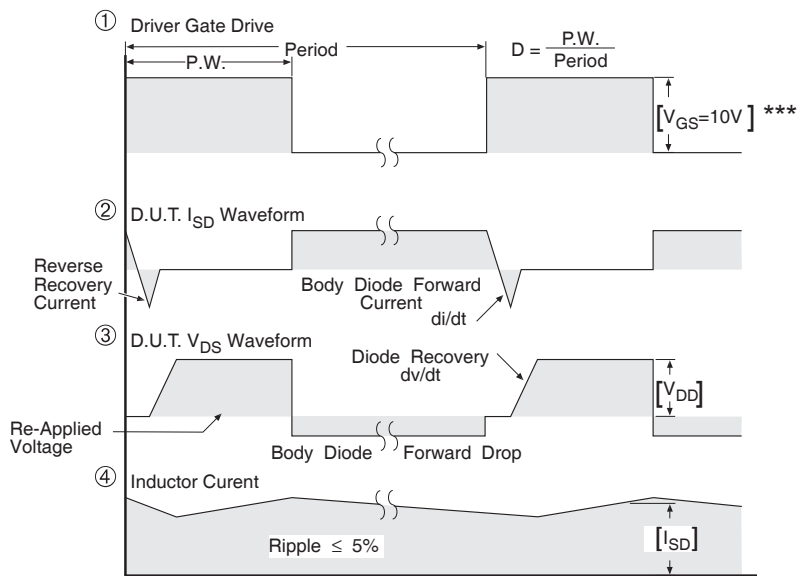

*** $V_{GS} = 5.0V$ for Logic Level and 3V Drive Devices

Fig 24. For N and P Channel HEXFETS

SO-8 Package Outline

Dimensions are shown in millimeters (inches)

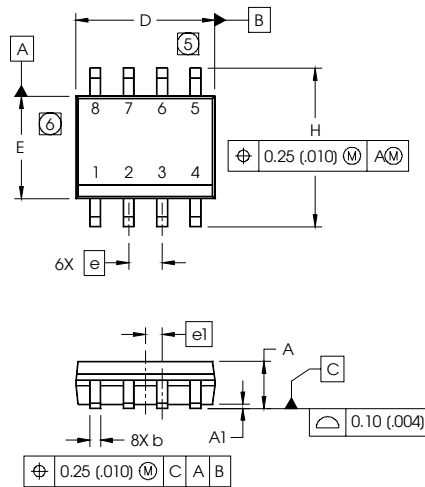

DIM	INCHES		MILLIMETERS	
	MIN	MAX	MIN	MAX
A	.0632	.0688	1.35	1.75
A1	.0040	.0098	0.10	0.25
b	.013	.020	0.33	0.51
c	.0075	.0098	0.19	0.25
D	.189	.1968	4.80	5.00
E	.1497	.1574	3.80	4.00
e	.050 BASIC		1.27 BASIC	
e1	.025 BASIC		0.635 BASIC	
H	.2284	.2440	5.80	6.20
K	.0099	.0196	0.25	0.50
L	.016	.050	0.40	1.27
y	0°	8°	0°	8°

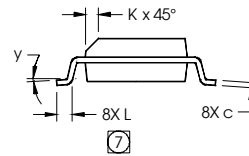

- NOTES:
1. DIMENSIONING & TOLERANCING PER ASME Y14.5M-1994.
 2. CONTROLLING DIMENSION: MILLIMETER
 3. DIMENSIONS ARE SHOWN IN MILLIMETERS (INCHES).
 4. OUTLINE CONFORMS TO JEDEC OUTLINE MS-012AA
 - ⑤ DIMENSION DOES NOT INCLUDE MOLD PROTRUSIONS. MOLD PROTRUSIONS NOT TO EXCEED 0.15 (.006).
 - ⑥ DIMENSION DOES NOT INCLUDE MOLD PROTRUSIONS. MOLD PROTRUSIONS NOT TO EXCEED 0.25 (.010).
 - ⑦ DIMENSION IS THE LENGTH OF LEAD FOR SOLDERING TO A SUBSTRATE.

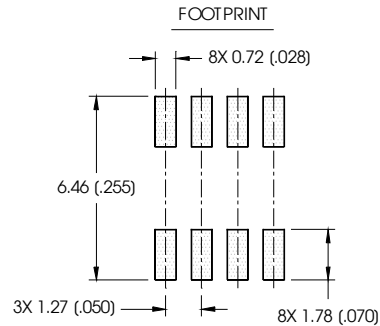

SO-8 Part Marking

EXAMPLE: THIS IS AN IRF7101 (MOSFET)

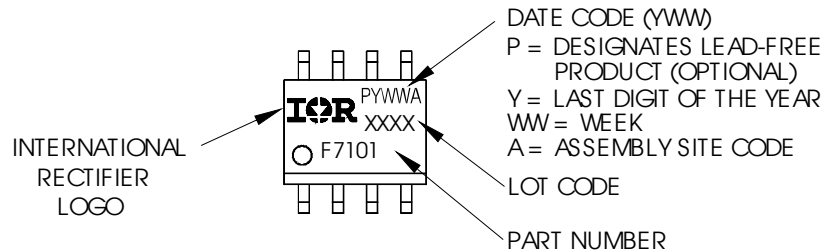

Notes:

1. For an Automotive Qualified version of this part please see <http://www.irf.com/product-info/auto/>
2. For the most current drawing please refer to IR website at <http://www.irf.com/package/>

IRF7105QPbF

International
IR Rectifier

SO-8 Tape and Reel

Dimensions are shown in millimeters (inches)

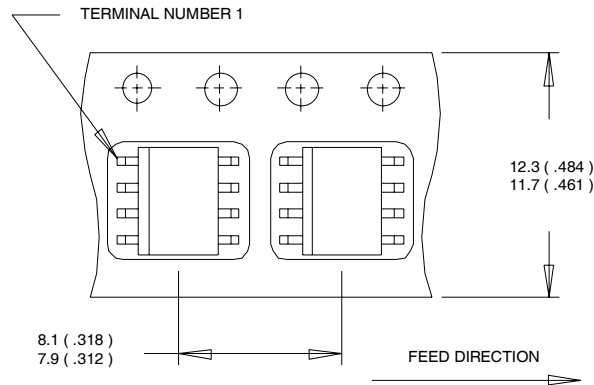

NOTES:

1. CONTROLLING DIMENSION : MILLIMETER.
2. ALL DIMENSIONS ARE SHOWN IN MILLIMETERS(INCHES).
3. OUTLINE CONFORMS TO EIA-481 & EIA-541.

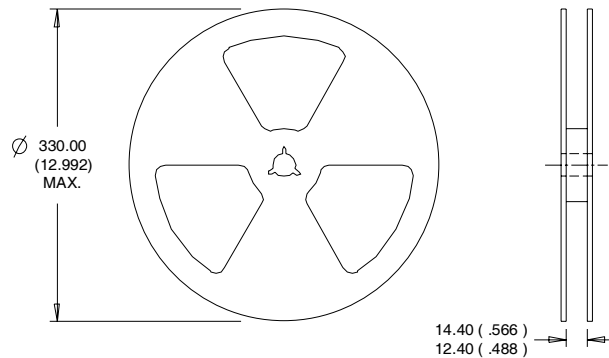

NOTES :

1. CONTROLLING DIMENSION : MILLIMETER.
2. OUTLINE CONFORMS TO EIA-481 & EIA-541.

Data and specifications subject to change without notice.
This product has been designed and qualified for the Industrial market.
Qualification Standards can be found on IR's Web site.

International
IR Rectifier

IR WORLD HEADQUARTERS: 233 Kansas St., El Segundo, California 90245, USA Tel: (310) 252-7105
TAC Fax: (310) 252-7903

Visit us at www.irf.com for sales contact information.08/2010