

8 Series Pushbutton Switches

■ Features

1. Contacts

Silver or gold-plated contacts.

2. Epoxy resin case

UL94V-0 self-extinguishing epoxy.

3. Actuator style

Over 30 actuator variations.

4. Insulation between terminal and ground: 4 mm minimum.

5. Prevention of flux entry

The epoxy resin seal on bottom of the switch helps prevent the entry of solder and flux.

6. Insulation barrier:

Insulation barrier design between poles helps prevent short-circuiting between poles ensuring high reliability.

7. For UL-recognized and CSA-approved products, please refer to P.280.

■ Specifications







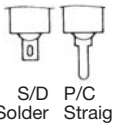

Rating	Max. rating	6A 125VAC/3A 250VAC/4A 30VDC	
Initial contact resistance	10m Ωmax.	(1A 2~4VDC)	
Initial dielectric strength	1,500VAC 1 minute		
Initial insulation resistance	1,000MΩ min.	(500VDC)	
Electrical life (Excluding 8R & 8W)	Alternate type	40,000 operations	
	Momentary type	25,000 operations	
Operating temperature range	-30°C~+85°C		
Storage temperature range	-40°C~+85°C		

(Excluding 8R & 8W. Specifications on 8R and 8W series are specified separately on P.271 and P.273.)

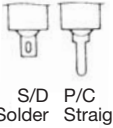
■ Terminal Styles

Solder (Style:1)	Straight (Style:2)
<p>t=0.8</p>	<p>t=0.8</p>

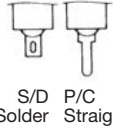
8 Series Pushbutton Switches Selection Table

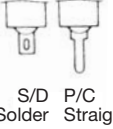
Part No.	Name	Actuator shape	Number of poles	Switching function	Terminal style	Page
8N	Standard Pushbutton		1.2.3.4	ON — ON ON — (ON)	 S/D Solder P/C Straight	265
8P	Splash Proof Pushbutton		1.2.3.4	ON — ON ON — (ON)	 S/D Solder P/C Straight	267
8Y	Mustang Pushbutton		1.2.3.4	ON — ON ON — (ON)	 S/D Solder	269
8R-N	Soft Touch Pushbutton		1.2	ON — ON ON — (ON)	 S/D Solder P/C Straight	271
8W-N	Snap-in Pushbutton		1.2	ON — (ON)	 S/D Solder P/C Straight	273

Part Numbering

8
N
1
01
1
B
—
Z

Series code Actuator shape Number of poles Switching function Terminal style (※1) Contact plating and material

Code	Actuator
N	Standard
P	Splash proof
Y	Mustang
R	Soft Touch
W	Snap-in

Fig.	Number of poles
1	1
2	2
3	3
4	4

Fig.	Switching function
01	ON — ON
02	ON — (ON)

Fig.	Terminal style
1	Solder
2	PC/Straight

Code	Contact material	Plating
None	Bs+Ag or Cu+Ag	Ag
B	Bs or Cu	Ni+Au
C	Bs+Ag or Cu+Ag	Ni+Au

※1 Brass
 Copper
 Silver
 Nickel
 Gold

Note : Some combinations may not be available. Please check the "Table of Part Numbers" for each series.

8R-N



RoHS compliant

Soft Touch Pushbutton Switches



Features

The **8R** Soft-Touch Pushbutton switches has a unique snap action structure which provides light and soft tactile feel. The short travel distance (Alternate action: 2.5 mm, Momentary: 1 mm) and the low-profile design make the 8R series suitable for applications where panel space is limited.

Specifications

Rating	Silver plated	3A 125VAC (Resistive load)	
	Gold plated	Max. 60mA 30VDC (Resistive load)	
Initial contact resistance	Silver plated	10mΩ max. (1A 2~4VDC)	
	Gold plated	20mΩ max. (5mA 200μVAC)	
Initial Dielectric strength	1,000VAC 1 minute		
Initial insulation resistance	1,000MΩ min. (500VDC)		
Electrical life	25,000 operations (50,000 operations:Gold plate)		
Operating temperature range	-20°C~+85°C		
Storage temperature range	-40°C~+85°C		
Operating force	Alternate type	8R101-N-Z	3.92±1.96N
		8R201-N-Z	4.9± ^{2.94} _{1.96} N
	Momentally type	8R102-N-Z	2.94±0.98N
		8R202-N-Z	4.9± ^{1.96} _{0.98} N

Table of Part Numbers

Terminal style		1-pole	2-pole
Solder	ON - ON	8R1011-N-Z ★8R1011B-N-Z	★8R2011-N-Z ★8R2011B-N-Z
	ON -(ON)	8R1021-N-Z 8R1021B-N-Z	8R2021-N-Z ★8R2021B-N-Z
PC	ON - ON	☆8R1012-N-Z ☆8R1012B-N-Z	★8R2012-N-Z ★8R2012B-N-Z
	ON -(ON)	8R1022-N-Z ☆8R1022B-N-Z	8R2022-N-Z ★8R2022B-N-Z

PC Hole Layouts

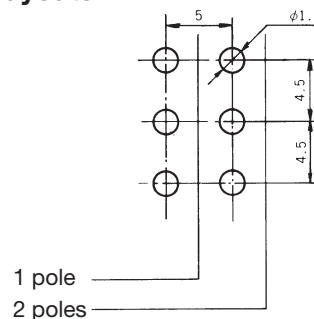

Terminal Styles Page 263.

Panel Cut-Out Dimensions

Panel thickness : 2 mm max.

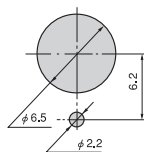

With Locking Ring

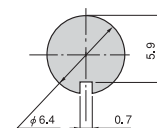

Without Locking Ring

SPDT



Terminal numbers are not shown on the switch.

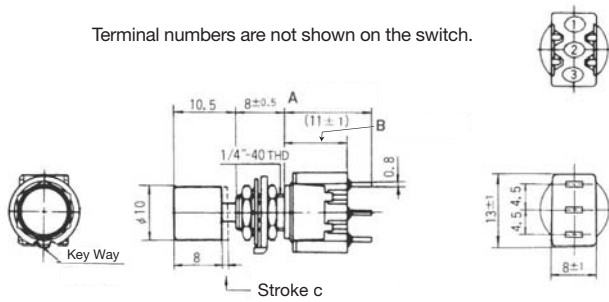

Switching function		
Part No.		
※ 8R101■-N-Z	ON	ON
8R102■-N-Z	ON	(ON)
Connecting terminals	3-2	3-1

■ : Please refer to "Table of Part Numbers" on P.271 for a list of full part numbers.

DPDT



Terminal numbers are not shown on the switch.

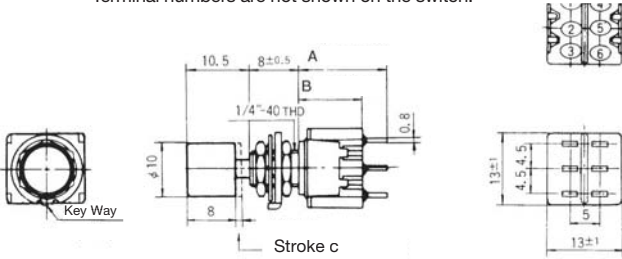

Switching function		
Part No.		
※ 8R201■-N-Z	ON	ON
8R202■-N-Z	ON	(ON)
Connecting terminals	3-2 6-5	3-1 6-4

■ : Please refer to "Table of Part Numbers" on P.271 for a list of full part numbers.

Standard Accessories (8R & 8R)

《Supplied with switch》

Hex Nut	Lockwasher	Locking Ring
140008010241	140008030051	140008020062
Nickel plated	Zinc plated	Zinc plated

Color Button Mounting

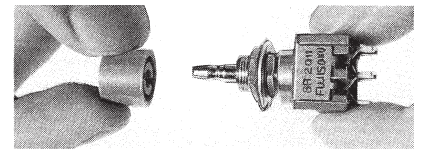

Snap in the color button on to the actuator.

Part name	Color Button			
Dimension A	φ 8	φ 10	φ 15	
Dimension B	7.5	8	10	
<p>(Material : PA)</p>	White	140000481420	140000480082	140000480088
	Red	140000481421	140000480083	140000480089
	Black	140000481422	140000480081	140000480090
	Gray	140000481423	140000480084	140000480091
	Green	140000481424	140000480085	140000480092
	Blue	140000481425	140000480086	140000480093
	Orange	140000481426	140000480087	140000480094
	Yellow	140000481427	140000480371	140000480372

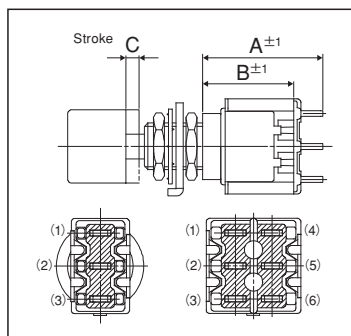

Terminal Style	Number of poles	Switching Function	Parts No.	Dimension A	Dimension B	Dimension C
S/D	1 pole	ON - ON	8R1011■-N-Z	16.5	12.5	2.5
		ON - (ON)	8R1021■-N-Z	15.0	11.0	1.0
	2 poles	ON - ON	8R2011■-N-Z	16.5	12.5	2.5
		ON - (ON)	8R2021■-N-Z	15.0	11.0	1.0
P/C	1 pole	ON - ON	8R1012■-N-Z	18.9	12.5	2.5
		ON - (ON)	8R1022■-N-Z	17.4	11.0	1.0
	2 poles	ON - ON	8R2012■-N-Z	18.9	12.5	2.5
		ON - (ON)	8R2022■-N-Z	17.4	11.0	1.0

■ : Blank for silver-plated contacts. "B" for gold-plated contacts. □ : Gold plated

●Hex Nut (2 pcs), Lockwasher (1 pc), and Locking Ring (1 pc) are supplied with the switch. A Color Button is also supplied with the switch. Please specify the part number from the above table when ordering.

(ON) : Momentary.

Eight Switch

Panel Cut-Out Dimensions

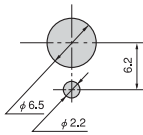
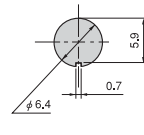
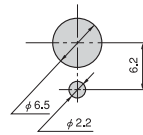
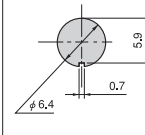
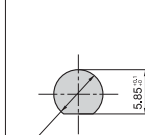
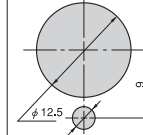
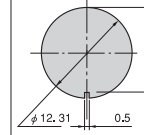
Series	8N		8R		8P	8Y	
Panel thickness	1.5 mm Max.	2.5 mm Max.	2 mm Max.	3 mm Max.	4.5 mm Max.	5 mm Max.	6 mm Max.
Dimensions							
	With Locking Ring	Without Locking Ring	With Locking Ring	Without Locking Ring		With Locking Ring	Without Locking Ring

PC Hole Layouts

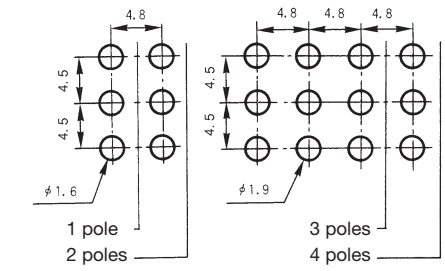
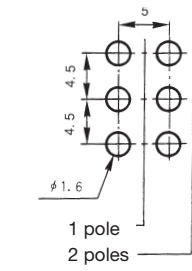
Series	8N · 8P	8R · 8W
Dimensions		

Precautions (8N·8P·8R·8W·8Y)

1. Soldering Specifications

(1) Manual soldering

Device : Solder iron

① 420°C Max. 3 sec. Max.

(2) Auto soldering

② 275°C ±10°C 5 sec. Max.

The above-stated soldering conditions shall apply only to switches with straight terminals. Auto soldering is not possible with right-angle terminals. Switches with right-angle terminals should be soldered manually according to the conditions specified in (1) above.

(3) When putting the switches through an aging process after they were soldered onto the printing board or after installed into a complete end product, be sure to remove the buttons of the switches.,

2. Mounting

- Do not bend the terminals before mounting the switch on the PC board.
- After mounting the switch, do not place the device in such a way that the device weight will be applied on to the actuator of the switch.
- For switches with straight terminals, solder the switch on the PC board after fixing the switch on the panel with a nut.

3. Flux Cleaning

- (1) Solvent : Fluorine or Alcohol type.
- (2) **8A/B/C/D/E/F/J/S** series are not washable. To wash the PC board, clean the soldering surface of the PC board with a brush so that the switch is not exposed to the cleaning solution.

Packaging Specification

